

Cerraduras

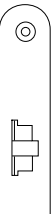

Características	Mod. 900	Mod. 895	Mod. 890	Mod. 887
Tipo de llave	—	—	—	sin cilindro cilindro europerfil
Accionamiento	manilla	condena	manilla y condena	llave
Centro	40,50,60,70	40,50,60,70	40,50,60,70	40,50,60,70
Mano	reversible	reversible	guarda mano dcha. e izda.	reversible
Distancia entre ejes	—	—	70	—
Acabados	LM, LB, IM, IB	LM, LB, IM, IB	LM, LB, IM, IB	LM, LB, IM, IB
Resbalón	silencios	—	silencioso	—
Otras Características	∅ 8mm. orificios pasantes 38-40mm. Caja centrada respecto al frente	∅ 6mm. (opcional ∅ 7-8mm.)	manilla ∅ 8mm. condena ∅ 6mm. orificios pasantes 38-40mm.en manilla. Caja centrada respecto al frente	—
<p>PR</p> <p>Todos los modelos están disponibles con frente y cerradero en Punto Redondo</p> 				

(*) LM: latón mate, LB: latón brillo, IM: inox. mate, EO: esmalte oro.

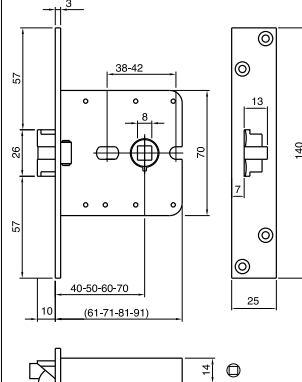
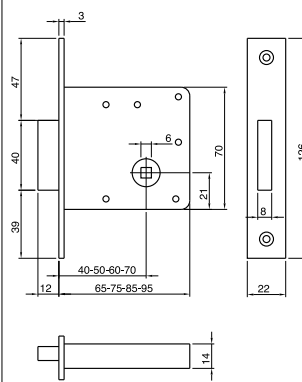
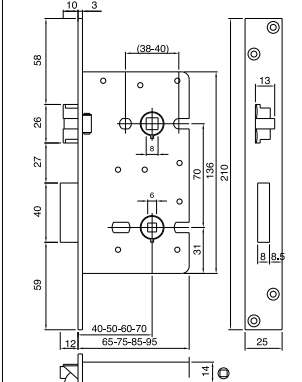
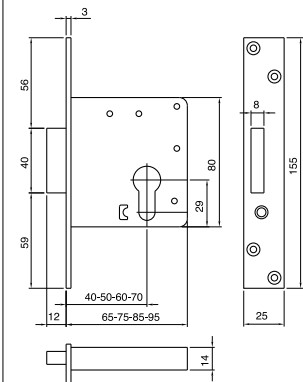

Mod. 885	Mod. 883	Mod. 880	Mod. 870	Mod. 865
—	sin cilindro cilindro europerfil	gorjas macho	—	—
llave	llave	manilla y llave	manilla	condena
40,50,60,70	40,50,60,70	40,50,60,70	40,50,60,70	40,50,60,70
reversible	guarda mano dcha. e izda.	guarda mano dcha. e izda.	reversible	reversible
—	72	70	—	—
LM, LB, IM, IB	LM, LB, IM, IB	LM, LB, IM, IB	LM, LB, IM, IB	LM, LB, IM, IB
—	silencioso	silencioso	—	—
—	∅ 8mm. orificios pasantes 38-40mm. en manilla Caja centrada respecto al frente	∅ 8mm. orificios pasantes 38-40mm. en manilla	∅ 8mm. para puerta corredera	∅ 6-8mm. para puerta corredera

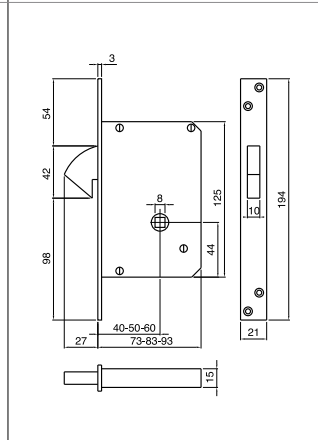
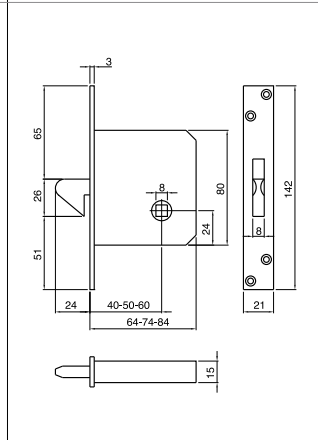
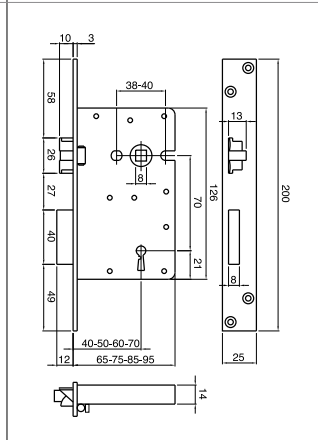
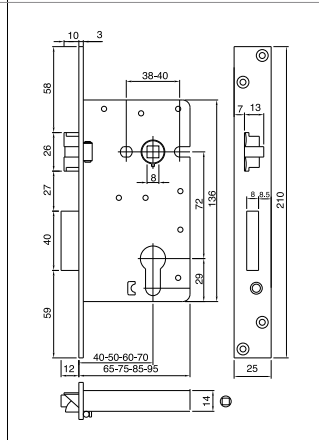
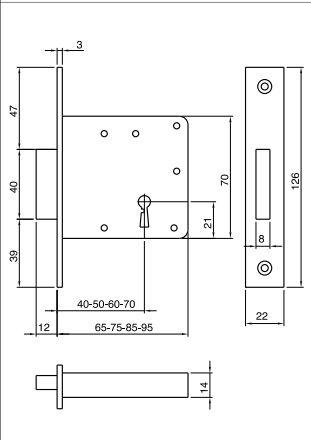

Cerraduras



Características	Mod. 863	Mod. 860	Mod. 840	Mod. 820
Tipo de llave	sin cilindro cilindro europerfil	gorjas macho	gorjas macho	gorjas hembra
Accionamiento	llave	llave	llave	manilla y llave
Centro	40,50,60	40,50,60	40,50,60	40,50,60
Mano	reversible	reversible	reversible	guarda mano dcha. e izda.
Distancia entre ejes	—	—	—	—
Acabados*	LM, LB, IM, IB	LM, LB, IM, IB	E0, EP	E0, EP
Resbalón	—	—	—	normal
Otras Características	para puerta corredera	para puerta corredera	—	∅ 8mm.

PR

Todos los modelos están disponibles con frente y cerradero en Punto Redondo

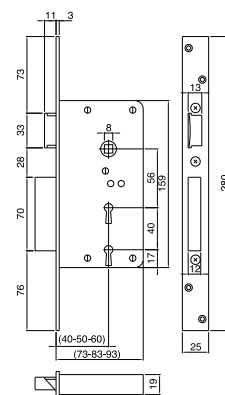
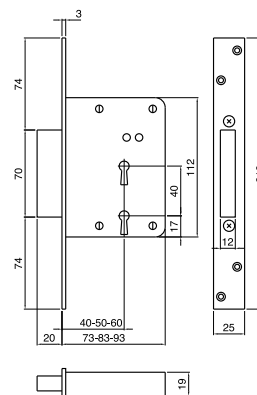
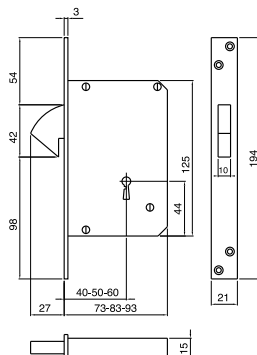
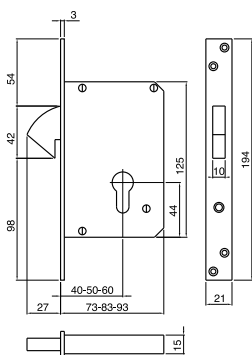
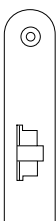

(*) LM: latón mate, LB: latón brillo, IM: inox. mate, E0: esmalte oro, EP: esmalte plata.



Mod. 811	Mod. 806	Mod. 84	Mod. 82	Mod. 82S
sin cilindro cilindro europerfil	sin cilindro cilindro europerfil	gorjas hembra	gorjas hembra	gorjas hembra
manilla y llave antipánico antitarjeta	manilla y llave antitarjeta	llave	manilla y llave	manilla y llave
50	50	40,50,60	40,50,60	40,50,60
guarda mano dcha. e izda.	guarda mano dcha. e izda.	reversible	guarda mano dcha. e izda.	guarda mano dcha. e izda.
72	72	—	interior 56 exterior 97	interior 56 exterior 97
LM, LB, IM, IB	LM, LB, IM, IB	LM, LB, IM, IB	LM, LB, IM, IB	LM, LB, IM, IB
silencioso	silencioso	—	normal	silencioso
∅ 8mm. orificios pasantes 38-40mm. en manilla 28-30mm cilindros. antipánico y antitarjeta	∅ 8mm. orificios pasantes 38-40mm. en manilla 28-30mm cilindros. antitarjeta	—	∅ 8mm.	∅ 8mm.